

Varenummer: 0110041
 Beskrivelse: Seeger låsering JS 24X1,5
 Fjederstål

Mål

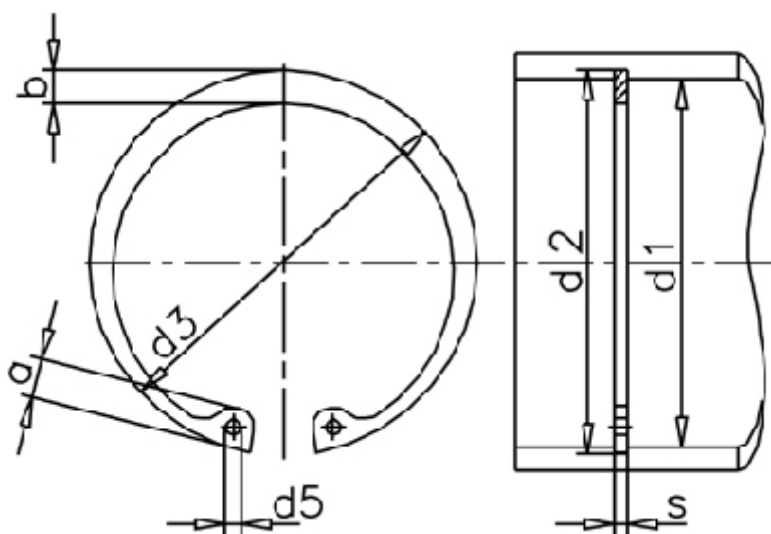

a max	= 4.9	d5 min	= 2.0	t	= 0.60
AN mm ²	= 46	FN kN	= 7.7	Tang	= ZGJ-2
B	= 1.60	FRg kN	= 7.2	tol	= 0.20
b	= 3.0	FR kN	= 21.7	tol	= +0,42 -0,21
Betegnelse	= JS 24	g	= 1.0	tol	= -0.06
d1	= 24	m min	= 1.60	vægt kg/1000	= 2.0
d2	= 25.2	Nominel træk	= 1.8		
d3	= 25.9	s	= 1.50		